



Using scale to represent designs and communicate plans.

<p><b>Description:</b> Students will learn about the ongoing issues associated with drought in California and how water conservation can be part of a solution. Students will design a rooftop water catchment system for drought-conscious Ms. Drizzle to install at her house. Then they will create a scale drawing of their system and present their final design to Ms. Drizzle for approval.</p>	
<p><b>Grade Levels:</b> 4-7</p>	<p><b>Objectives:</b> Students will:</p> <ul style="list-style-type: none"> <li>• Build and test a rain catchment system that will direct rain into a rain barrel.</li> <li>• Collect data on the amount of rain captured in the rain barrel after 2-3 trials.</li> <li>• Reflect on materials used in the design process and for iteration.</li> <li>• Plan and carry out investigations.</li> <li>• Use data to guide iteration.</li> <li>• Focus on materials, their properties, and their use.</li> </ul>
<p><b>Duration:</b> Five or six 60-Minute Sessions</p>	<p><b>Standards Connections:</b></p> <p><b>Common Core State Standards (CCSS)</b> CCSS 7.GA.1: <b>Solve problems involving scale drawings of geometric figures, including computing actual lengths and areas <i>from a scale drawing</i> and reproducing a scale drawing at a different scale.</b></p> <p><b>NGSS Science and Engineering Practices (SEP)</b> 3, 6-8 Planning and Carrying Out Investigations</p> <ul style="list-style-type: none"> <li>• <b>Collect data about the performance of a proposed object, tool, process, or system</b> under a range of conditions.</li> </ul> <p><b>NGSS Cross Cutting Concepts (CCC)</b> 3, 6-8 Structure and Function</p> <ul style="list-style-type: none"> <li>• <b>Structures can be designed to serve particular functions by taking into account</b> properties of different materials, and <b>how materials can be shaped</b> and used.</li> </ul>

**Materials:**  
Below there are categories of materials for students to build with that include suggestions for types of items. Look around your classroom and school, or ask students to bring in the materials you all can use during the design challenge. Material quantities are for a class of 32 students, in teams of 3 to 5 students per team.

Drain Pipes (100 total)	Supports (100 total)
<ul style="list-style-type: none"> <li>• Paper towel rolls</li> <li>• Toilet paper rolls</li> <li>• Pipe insulation foam tubes</li> <li>• <math>\frac{3}{4}</math>-1" PVC pipe pieces                             <ul style="list-style-type: none"> <li>- Connectors</li> <li>- Pipe cutter</li> </ul> </li> </ul>	<ul style="list-style-type: none"> <li>• Popsicle sticks</li> <li>• Tongue depressors</li> <li>• Straws</li> </ul>

This lesson is part of:  
The Tech Academies of Innovation

For more information visit:  
[thetech.org/techacademies](http://thetech.org/techacademies)



Supporting educators to develop  
the next generation of problem-solvers  
[thetech.org/bowersinstitute](http://thetech.org/bowersinstitute)



Rain barrels (2 per group)	Other Building Materials
<p>Clear plastic with <math>\frac{1}{3}</math> marked increments. Approximately 3" diameter and 4" tall.</p> <ul style="list-style-type: none"> <li>• Beaker</li> <li>• Can</li> <li>• Bucket</li> <li>• Cup</li> </ul>	<ul style="list-style-type: none"> <li>• Funnels</li> <li>• 15-20 cups of any size</li> <li>• (Optional) hot glue gun</li> <li>• (Optional) 10-15 strawberry baskets</li> </ul>

### Test Rig:

Build one rig for each team. All rigs should be identical in size and construction.

- 3-ring binders
- Cardboard box (large enough to support and elevate a 3-ring binder)
- 2 plastic drink cups per rig (10 oz sturdy plastic)
- Tray for each "house" to collect the kosher salt (half of a large shirt box works well)

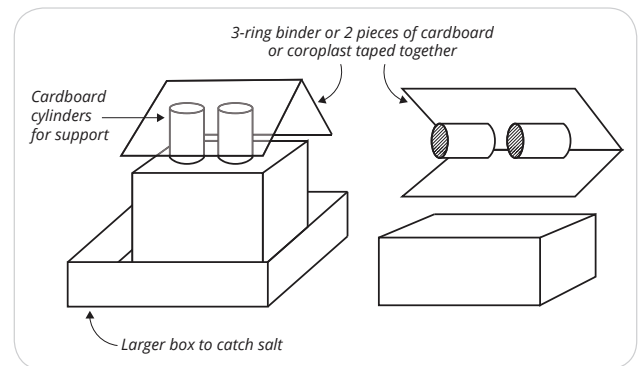

### Each table or building station:

- Masking tape or label stickers (to be used as tape — 1 roll per group or per teacher discretion).
- 2 cups of kosher salt to symbolize rain (three 3-lb boxes for the entire class for the unit).
  - Optional: table salt for lighter rain.
- A system to shake salt evenly over the house and device. Some ideas include:
  - A fine mesh strainer or sieve.
  - A cardboard box/aluminum tray with holes punched in the bottom.

### Prep:

- Prepare at least one rig for testing, or more if you want one rig per team (see above instructions). Rigs can be any size, but need to be able to elevate and support a 3-ring binder "roof".
- Put students into teams. A suggested group size for this unit is 3-5 students.
- Gather materials for teams and organize them on a table for easy student access.
- Print handouts needed during unit: Data Collection Sheets 1 & 2, Shopping List, School Board Proposal, and Rubric.

### Tech Tips:

These one-page guides provide tips and best practices for facilitating design challenges

- What is Engineering?
- Language of Engineering
- Materials
- Sharing Solutions
- Prototyping



## Lesson

### A. Introduction (20 Minutes)

1. Explain to students that they are going to solve a problem as an engineer to help address the droughts in California.
  - a. Tech Tip: What is Engineering? is a resource that can help guide this conversation.
  - b. For additional ideas for supporting students' engineering vocabulary development see Tech Tip: Language of Engineering.
2. Discuss the California drought with your class.
  - a. Ask the students what they already know.
  - b. For resources to help develop context see Appendix C: Resources - Drought.
  - c. Possible facilitative questions include:
    - i. How has the California drought affected you?
    - ii. Does your family do anything to save water? If so, what does your family do?
    - iii. What questions do you have about droughts?
    - iv. (Resource questions) In reviewing drought resources, what facts surprised you?
3. Introduce the engineering challenge scenario that students will be working to solve over the course of the unit.

*Ms. Drizzle is a conscientious Californian who would like to do her part to help save water during the CA drought. She decided that using rain barrels to collect water for her yard was something she wants to do to help. She has come to your company to get help designing a rainwater catch system for her roof.*

4. Lead students in a discussion about how rain collection works.
  - a. Ask facilitative questions to gauge student knowledge of the topic.
    - i. *Why would we want to reuse rainwater?*
    - ii. *Could we drink the rainwater? Why or why not?*  
(Answer: no, collected rainwater is unsafe to drink because it is exposed to animal contaminants and other pollutants as it runs down a roof.)
    - iii. *What can we use the rainwater for?*
  - b. Analyze an image of a water barrel for rain water storage with the class.  
"Rain Barrel." Tip of the Mitt, Watershed Council. Web. 9 August 2018.  
<http://www.watershedcouncil.org/uploads/7/2/5/1/7251350/633260.jpg?731>
    - i. *What are the different pieces we see and what do they do?*
    - ii. *What questions do you have about this device for storing rainwater?*
    - iii. *What are you curious about or might you want to change on this device?*

### B. Engineering Challenge (60 Minutes)

1. Introduce the engineering design challenge.

#### **Design Problem:**

Design a system for Ms. Drizzle to collect rainwater from her roof.

#### **Criteria (Design Requirements/Desired Features):**

- Measure/collect as much rainwater as possible in the provided rain barrel.
- Rain barrel must be on the "ground".
- Collection system must be self-supporting (let go while testing).
- All members of the group must participate.



## Constraints (Design Limitations):

- Each team gets one rain barrel and they are limited to collecting the amount of water that fits in the barrel. (Amounts vary based on what educator uses as a rain barrel.)
- Budget: Use only materials provided
- Schedule: 30 minutes to build and test before share out

## Testing:

- Use kosher salt and a distribution device (i.e. salt shaker or tray with holes punched in the bottom) to distribute the salt all over the “roof of the house”. (See Set Up section for details.)
- Ensure students have more than enough salt to fill the simulated rain barrel.
- Testing should be done throughout the design process, not just at the end.

## 2. Introduce the concepts of **optimization** and **trade-offs**.

- In this challenge, your goal is to help Mrs. Drizzle collect as much rainwater as possible for her to use in her garden. However, she will want a system that doesn't overuse materials or adds unnecessary weight to the roof.*
- How do we help Ms. Drizzle build a system that catches a lot of rainwater without covering her entire roof with pipes and fittings?*  
(Possible answers include: we can build and test our ideas measuring how much rain we catch, we can make a goal and design to reach that goal, we can see what looks nice and works.)
- Designing a system like this in real life includes considerations like cost, time to build, and how the system functions and looks. Balancing these types of criteria and constraints requires that the designer make **trade-offs**. For example, Ms. Drizzle could cover her whole roof with pipes to catch nearly all of the water that falls on her roof, but the **trade-off** would be that she would spend the most money, it would take the longest to build, and her rain barrel might overflow. Most likely, Ms. Drizzle will weigh these **trade-offs** to find a design that fits her budget and needs, creating her **optimal design** (the design that best meets the criteria and constraints).*

## 3. Give each student group a few of the materials provided and 10 minutes to think about how they can be used in their design. For more ideas on how to explore materials with student groups, see Tech Tip: Managing Materials.

- Have students manipulate materials and discuss ways they could be used in Ms. Drizzle's roof system. The purpose of this activity is for students to become familiar with their building supplies.
- Possible facilitative questions include:
  - What properties do these materials have that would make them useful for this challenge?*
  - How would you describe the shape, size, and flexibility of the materials?*
  - Which materials might work well together? How?*

## 4. Give student teams the data collection worksheet

(see Appendix D: Handouts - Catch it if you can: Data Collection - Design Challenge 1).

- Discuss with students how you want them to draw their device, record “water” collection, and write about optimization of the design and materials.

## 5. Give students 30 minutes to gather materials, build, and test. Encourage students to test all or parts of their solutions during this time.

- Remind teams to record their data on the data collection sheet.
- While students are building, walk around and ask questions:
  - Which materials did you choose and why?*
  - What **trade-off** are you making? What have you learned from this?*
  - What do you think is the **optimal** amount of water to catch with the optimal amount of device?*
  - Did anyone's barrel overflow? What might that mean for our designs?*

(Possible answers include: we need more barrels, we need to collect less water for this system.)



6. Gather students after 30 minutes to allow teams to see each other's designs. For more ideas on how to conduct share outs see Tech Tip: Sharing Solutions.
  - a. Facilitative questions to ask during this share out could include:
    - i. *Which parts of your design worked as you expected?*
    - ii. *What types of materials worked well in your design?*
    - iii. *How did you decide when your design was a good balance of catching water and aesthetic design?*

## C. Content Learning (60 Minutes)

1. *Ms. Drizzle likes your design very much and she would like for your company to help her get permits and materials to make the water catch system a reality. To do this she is going to need a scale drawing of the roof with a picture of your catchment system and a complete shopping list.*
2. Give each student a copy of Ms. Drizzle's Shopping List (Appendix D: Handouts - Ms. Drizzle's Shopping List).
  - a. Students will be measuring their model, determining scale factor and the width of the roof, making a scale drawing, and determining the length of materials needed for the project.
3. Teach, model, and practice how to find a scale factor and apply it to a modeling situation as a class.
  - a. Optional: Khan Academy video explaining how to make scale drawings using scale factor  
"Making a Scale Drawing." Web. 9 August 2018.  
<https://www.khanacademy.org/math/cc-seventh-grade-math/cc-7th-geometry/cc-7th-scale-drawings/v/constructing-scale-drawings>
4. Have students demonstrate their understanding by completing Ms. Drizzle's Shopping List.
  - a. Possible facilitative questions include:
    - i. *How will you know that your numbers are accurate? How can we use other math skills to check our work?*
    - ii. *What other information does Ms. Drizzle need to build this system?*
    - iii. *What questions do you have?*

## D. Iterate Solution (40 Minutes)

1. *Ms. Drizzle has made your water collection system and it has worked really well! However, there some heavier rain storms over the winter and her barrel overflowed when it rained heavily. She asks you to redesign her system to handle heavier than normal rains by incorporating another water barrel somewhere in the system.*
  - a. Lead a discussion with students about places where the barrel could be incorporated.
  - b. (Possible answers include: attached to the first barrel to collect overflow; along a different part of the roof; in a different area of her yard to allow for watering the plants in a different part of the yard; etc.)
  - c. Review the value of considering **trade-offs** and **optimization** in design and material considerations.
2. Share the second engineering design challenge, with the new modifications.

### Design Problem:

Design a system for Ms. Drizzle to collect rainwater from her roof.

### Criteria (Design Requirements/Desired Features):

- Measure/collect as much rain water as possible in the provided rain barrels.
- Rain barrels must be on the "ground".
- Collection system must be self-supporting (let go while testing).
- All members of the group must participate.



## Constraints (Design Limitations):

- Each team gets two rain barrels and they are limited to collecting the amount of water that fits in the barrel. (Amounts vary based on what educator uses as a rain barrel.)
- Budget: Use only materials provided.
- Schedule: 20 minutes to build and test before share out.

## Testing:

- Use kosher salt and a distribution device (i.e. salt shaker or tray with holes punched in the bottom) to distribute the salt all over the “roof of the house”. See Set Up section for details.
  - a. Double the amount of salt provided in the first challenge.
- Ensure students have more than enough salt to fill the simulated rain barrel.
- Testing should be done throughout the design process, not just at the end.

3. After discussing the design challenge have student teams develop their second **prototype**. (Tech Tip: Prototyping provides guidance on facilitating and supporting the prototyping process.)
  - a. Give each team a data collection sheet (Appendix D: Handouts - Catch it if you can: Data Collection - Design Challenge 2)
  - b. Make sure each team records their data for the second design challenge.
4. Lead students through the final testing of their system design as a whole class. Have each team test one at a time.
  - a. Ask the following facilitation questions:
    - i. *How did the structure or shape of your design improve the function of collecting “water”?*
    - ii. *Given what you know about using a barrel for water collection, how did your roof design change when adding the second barrel?*
    - iii. *What **trade-offs** did your team make to **optimize** your design?*
    - iv. *Was there anything surprising between the data you got from the first design challenge versus the second design challenge?*

## E. Evaluation (120 Minutes)

1. *Ms. Drizzle is using her rainwater collection system and is so happy with the work you have done for her. The roof looks nice, she has plenty of water for her garden, and her rain barrel doesn't overflow anymore. She wants to give back to the community and encourage students to think about conserving water. She wants to pay to have a rainwater collection system built at a local school, but she has to convince the school to accept this gift. She has hired your team again to complete a proposal to submit to the school board.*
2. Explain the assessment to the students.
  - a. Provide each student with a sheet explaining the assessment. (See Appendix D: Handouts - School Board Proposal.)
  - b. Provide each student with a rubric and explain how it ties to their learning objectives. (See Appendix D: Handout - Rubric.)
  - c. For Educator consideration:
    - i. If time allows, have your students measure the length and width of a building on their campus for their proposal.
    - ii. Consider having an authentic audience for this design challenge. Who can you get to look or listen to student proposals: principals, local garden club, construction company, or school board.
3. Give students class time to create their School Board Proposals. Consider giving them 45-100 minutes.



## Appendix A – Grade Level Modifications

Grade	Standard	Modifications
All	Technology Integration	<p>“Geogebra” is an online drawing tool where measurements can be set. Teams who are struggling to draw their drawings neatly on paper might prefer this tool, particularly if they’ve used it in the past. <a href="http://www.geogebra.org/">www.geogebra.org/</a></p> <ul style="list-style-type: none"> <li>• Expect 30-40 minutes of exploration before students can use it successfully to complete this task using Geogebra.</li> <li>• Benefits include: A coordinate plane can be placed behind Geogebra drawings, which is helpful if students would like to explore the related Math 8 Dilation standard as an extension.</li> </ul> <p>Tinkercad is an online 3D modeling tool. Students might also explore as an extension. <a href="http://www.tinkercad.com/#/">www.tinkercad.com/#/</a></p>
6	<p>CCSS.MATH.CONTENT.6.RP.A.1 Understand the concept of a ratio and use ratio language to describe a ratio relationship between two quantities.</p>	<p>Students create a shopping list but do not create a scale drawing. The final assessment may still be completed with the proposal for the school board including the materials list for budget purposes, a written proposal or presentation, and possibly a non-scale diagram.</p>
5	<p>CCSS.MATH.CONTENT.5.MD.1 Convert like measurement units within a given measurement system. 1. Convert among different-sized standard measurement units within a given measurement system (e.g., convert 5 cm to 0.05 m), and use these conversions in solving multi-step, real-world problems.</p>	<p>Have students measure the parts of their system using metric measurements in centimeters. Then have students convert all measurements to meters. The final assessment can be completed with a written proposal or presentation to the school board without scale materials.</p>
4	<p>CCSS.MATH.CONTENT.4.G.A.2 Classify two-dimensional figures based on the presence or absence of parallel or perpendicular lines, or the presence or absence of angles of a specified size. Recognize right triangles as a category, and identify right triangles.</p>	<p>Have students calculate the perimeter and area of the model roof using measurements. If given the real-world measurements of Ms. Drizzle’s roof, they can also calculate the real-world perimeter and area. In addition to this, students can identify right angles, perpendicular angles and parallel lines on their system.</p>



## Appendix B – Vocabulary

The following is the start of a suggested list of words to discuss as your progress through this unit with students. For more in depth information about vocabulary and teaching information, visit [Tech Tip: Language of Engineering](#).

Term	Student-friendly definition
prototype	The model(s) that you build to test before you get to your final solution.
optimal design	The design or machine that best meets the criteria and constraints.
optimization	The process of iterating, refining and making trade-offs until a solution is found that best meets the criteria within given constraints.
scale	A ratio that compares a model's size to the actual size.
scale factor	The model's measurements can be multiplied by a scale factor to get the actual measurements.
trade-off	A situation in which you must choose between or balance two things that are opposite or cannot be had at the same time.





## Appendix C - Resources

### Drought

<b>Infographic on California Drought</b>	<p>Kowal, Kathleen M. "California Drought." Visual.ly, Kathleenkowal.com, 17 May 2015. Web. 28 July 2018.</p> <p><a href="https://visual.ly/community/infographic/environment/california-drought">https://visual.ly/community/infographic/environment/california-drought</a></p>
<b>California Drought in global context</b>	<p>"How California's Drought Affects The World." YouTube, Seeker, 19 March 2015. Web. 28 July 2018.</p> <p><a href="http://www.youtube.com/watch?v=plet8eXDfBk&amp;feature=youtu.be&amp;t=16s">www.youtube.com/watch?v=plet8eXDfBk&amp;feature=youtu.be&amp;t=16s</a></p>
<b>General Information on Rain Barrels</b>	<p>"Buying, Installing and Using a Rain Barrel." Lowes. Web. 9 August 2018.</p> <p><a href="https://www.lowes.com/projects/gardening-and-outdoor/buying-installing-and-using-a-rain-barrel/project">https://www.lowes.com/projects/gardening-and-outdoor/buying-installing-and-using-a-rain-barrel/project</a></p>
<b>Rainwater Catchment Calculator</b>	<p>"Rainwater Catchment Calculator." Innovative Water Solutions, Water Cache. Web. 9 August 2018.</p> <p><a href="https://www.watercache.com/resources/rainwater-collection-calculator">https://www.watercache.com/resources/rainwater-collection-calculator</a></p>
<b>GeoGebra</b>	<p>"GeoGebra   Free Math Apps - Used by over 100 Million Students &amp; Teachers Worldwide." GeoGebra -Dynamic Mathematics. Web. 27 August 2018.</p> <p><a href="http://www.geogebra.org">www.geogebra.org</a></p>
<b>Tinkercad</b>	<p>"Create 3D Digital Designs with Online CAD." Tinkercad. Web. 27 August 2018.</p> <p><a href="http://www.tinkercad.com">www.tinkercad.com</a></p>



## Appendix D - Lesson Handouts

Handout	Page
Data Collection Sheet - Design Challenge 1	11
Data Collection Sheet - Design Challenge 2	12
Ms. Drizzle's Shopping List	13
School Board Proposal	14
Rubric	15



## Catch it if You Can: Data Collection

Record your test data below. Be sure to iterate and test at least 2 times.

### Design Challenge 1

Draw your **prototype** using pencil or insert an image  using your device's camera.

<p>Show the rain collected in each barrel. Place a point on each line.</p> <p>Barrel 1:</p> 	<p>Materials used:</p>
---	------------------------

### Trial 2

<p>Show the rain collected in each barrel. Place a point on each line.</p> <p>Barrel 1:</p> 	<p>Changes from previous <b>prototype</b>:</p>
---	--

### Trial 3

<p>Show the rain collected in each barrel. Place a point on each line.</p> <p>Barrel 1:</p> 	<p>Changes from previous <b>prototype</b>:</p>
---	--

What **trades-offs** did you make to **optimize** this device? (Discuss materials and shapes used in your design.)

---



---





## Catch it if You Can: Data Collection



Record your test data below. Be sure to iterate and test at least 2 times.

### Design Challenge 2



Draw your **prototype** using pencil or insert an image  using your device's camera.

<p>Show the rain collected in each barrel. Place a point on each line.</p> <p>Barrel 1:</p>  <p>Barrel 2:</p> 	<p>Materials used:</p>
--	------------------------

### Trial 2

<p>Show the rain collected in each barrel. Place a point on each line.</p> <p>Barrel 1:</p>  <p>Barrel 2:</p> 	<p>Changes from previous <b>prototype</b>:</p>
--	--

### Trial 3

<p>Show the rain collected in each barrel. Place a point on each line.</p> <p>Barrel 1:</p>  <p>Barrel 2:</p> 	<p>Changes from previous <b>prototype</b>:</p>
--	--

What **trades-offs** did you make to **optimize** this device? (Discuss materials and shapes used in your design.)

---



---



## Ms. Drizzle's Shopping List

It's time to help Ms. Drizzle provide the measurements needed to get her permits with City Hall and purchase materials.

### Step 1: Measure your model:

You are going to draw a scale drawing from a bird's eye view (rectangle) of one side of your rainwater catch system. Measure one side of your roof in inches.

Roof Length (inch)	Roof Width (inch)

### Step 2: Find the dimensions of the house:

One side of Ms. Drizzle's roof is 30 feet long. Figure out the roof width and scale factor for her roof.

Roof Length (feet)	Roof Width (feet)	Scale Factor
30 Feet		

### Step 3: Provide a scaled drawing of Ms. Drizzle's roof that will fit in this space:

Draw a scaled rectangle of Ms. Drizzle's roof and sketch in your rainwater catch system.

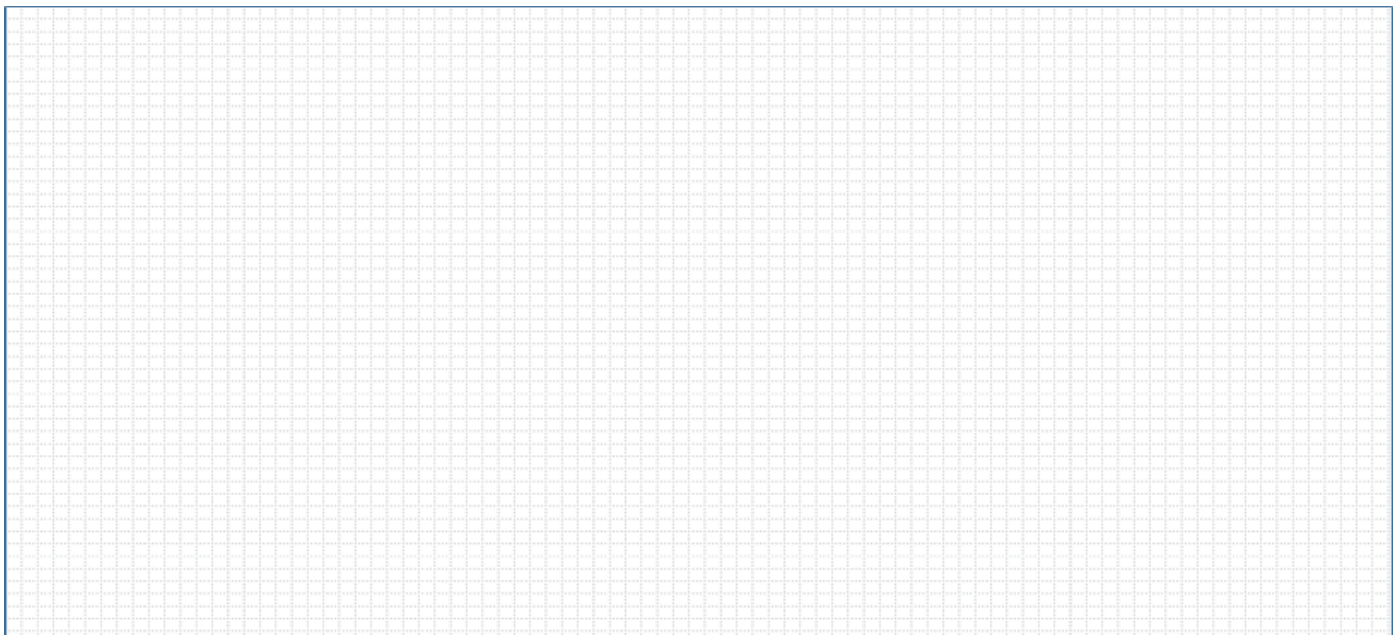

### Step 4: Ms. Drizzle's shopping list

Ms. Drizzle is very handy and figure out how things go together, but she would appreciate your help figuring out the lengths needed for the straight pieces in her system.

Material Type	Description	Length in feet



## School Board Proposal

Help Ms. Drizzle share her vision for saving water in San Jose with the school board by helping her put in a proposal.

**Why should the school board install a rainwater collection system?**

**Why should the school board hire your team to do the installation? Provide 2 reasons supported by data.**

(Please include data from your data collection sheets and a explanation of how your team has a design that uses appropriate trade-offs that create an **optimal design**.)

**What types of materials would you recommend using to build a rainwater catchment system?**

**Provide at least 2 examples with evidence and explain why.** (Include evidence from data collection and describe how these materials are optimal for the proposed shape, use or overall function.)

**Create and attach to-scale view designs for the school building, this includes:**

- 2 different views and measurements that cannot overlap with Ms. Drizzle's roof dimensions.  
Options include:
  - Roof
  - Side wall
  - Front wall
- Create a **scale** drawing with clearly labeled length, width, and **scale factor**.

# RUBRIC: Catch It If You Can!



	Below Standard	Approaching Standard	Meeting Standard	Above Standard
<p><b>CCSS Geometry</b>  <b>CCSS.MATH.</b>  <b>CONTENT.7.G.A.1</b>  <i>Solve problems involving scale drawings of geometric figures, including computing actual lengths and areas from a scale drawing and reproducing a scale drawing at a different scale.</i></p>	<ul style="list-style-type: none"> <li>• Student turns in a School Board proposal with inaccurate scale drawings.</li> </ul> <p><i>Areas that individual students may need one-on-one support with:</i></p> <ul style="list-style-type: none"> <li>• Figuring out scale factor.</li> <li>• Creating scaled drawings.</li> <li>• Applying scale factor.</li> </ul>	<ul style="list-style-type: none"> <li>• School Board proposal includes:               <ul style="list-style-type: none"> <li>– 1 accurate scale drawing with different dimensions than Ms. Drizzle's roof.</li> <li>– Scale factor is accurate.</li> </ul> </li> </ul>	<ul style="list-style-type: none"> <li>• School Board proposal includes:               <ul style="list-style-type: none"> <li>– 2 different scale drawings that are different from Ms. Drizzle's roof.</li> <li>– Length, width, and scale factors are accurate.</li> </ul> </li> </ul>	<p><i>Areas where students may exceed:</i></p> <ul style="list-style-type: none"> <li>• Thorough and detailed School Board proposal involving 3 or more scaled drawings with accurate scale factors, lengths, and widths.</li> </ul> <p><i>Ideas for next steps for growth:</i></p> <ul style="list-style-type: none"> <li>• Student uses computer tools to generate a scaled drawing with slope.</li> <li>• Student creates a working scaled model of their design out of building materials.</li> </ul>
<p><b>NGSS Planning and Carrying Out Investigations</b></p> <p>(SEP 3, 6-8).  <i>Collect data about the performance of a proposed object, tool, process, or system under a range of conditions.</i></p>	<ul style="list-style-type: none"> <li>• Student team turns in 1 Data Collection form with 50% complete.</li> <li>• Student turns in School Board proposal with a confusing answer to the second question.</li> </ul> <p><i>Areas that individual students may need one-on-one support with:</i></p> <ul style="list-style-type: none"> <li>• Recording data.</li> <li>• Team work.</li> <li>• Time management.</li> <li>• Explaining their choices.</li> </ul>	<ul style="list-style-type: none"> <li>• Student teams turn in 2 Data Collection forms with:               <ul style="list-style-type: none"> <li>– 2 trials of water collection documented.</li> <li>– At least 1 recorded diagram.</li> <li>– Materials used are identified.</li> </ul> </li> <li>• School Board proposal second question is answered, but no data is provided.</li> </ul>	<ul style="list-style-type: none"> <li>• Student teams turn in 2 Data Collection forms with:               <ul style="list-style-type: none"> <li>– 3 trials of water collection documented.</li> <li>– 2 recorded diagrams of prototypes.</li> <li>– Explanation of how materials were used in terms of trade-offs or optimization.</li> </ul> </li> <li>• School Board proposal includes at least 2 examples from data collection to support design decisions, trade-offs, and justification of an optimal design.</li> </ul>	<p><i>Areas where students may exceed:</i></p> <ul style="list-style-type: none"> <li>• Students label diagram of prototype.</li> <li>• Student provides accurate and thorough explanation of materials used, trade-offs, and how they optimized their device.</li> </ul> <p><i>Ideas for next steps for growth:</i></p> <ul style="list-style-type: none"> <li>• Students identify and develop other tests to collect data on their device.</li> <li>• Students research for formulas and water averages in San Jose to calculate how much rainwater can be collected from the school roof.</li> </ul>
<p><b>NGSS Structure and Function</b></p> <p>(CCC 3, 6-8).  <i>Structures can be designed to serve particular functions by taking into account properties of different materials, and how materials can be shaped and used.</i></p>	<ul style="list-style-type: none"> <li>• School board proposal provides a limited description of materials.</li> </ul> <p><i>Areas that individual students may need one-on-one support with:</i></p> <ul style="list-style-type: none"> <li>• Descriptive vocabulary.</li> <li>• Transferring abstract thoughts into words.</li> </ul>	<ul style="list-style-type: none"> <li>• Data collection sheet provides a limited description of materials used for the tests.</li> <li>• School board proposal answers the third question about materials without an explanation.</li> </ul>	<ul style="list-style-type: none"> <li>• School board proposal includes reasonable recommendations of materials and cites at least 2 examples from data collection supporting this recommendation.</li> </ul>	<p><i>Areas where students may exceed:</i></p> <ul style="list-style-type: none"> <li>• Student provides a specific material description to allow anyone to buy materials to complete the project at home.</li> </ul> <p><i>Ideas for next steps for growth:</i></p> <ul style="list-style-type: none"> <li>• Student creates a materials budget for Ms. Drizzle's roof or the school roof using their measurements and researching costs on a home supply shopping site.</li> </ul>